

JALADERAS PARA EMBUTIR



Guía de corte para mueble WFH112X50PSS

Formato sin escala

Corte de mueble

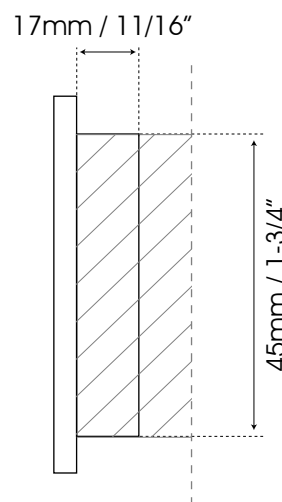
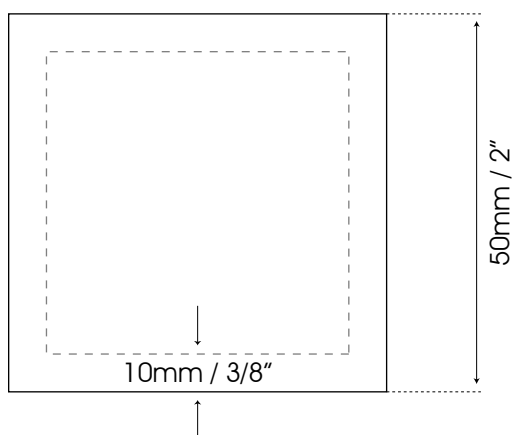
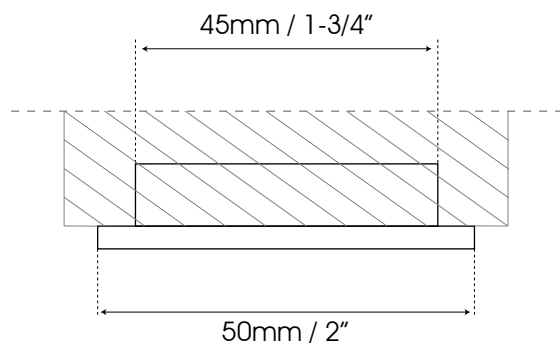

Aplicar pegamento
epóxico al borde.